

***D SERIES  
CATALOG  
Sliding Patio  
Screen Doors  
Lineals and Components***

**Corporate Office**

123 Oxmoor Road West • Birmingham, AL 35209  
P.O. Box 59226 • Birmingham, AL 35259-9226  
Telephone: 1/800/868-4100  
Fax: (205) 945-4304

**Mason-Dallas** • 2080 McDaniel, Suite 125  
Carrollton, TX 75006  
Telephone: 1/800/756-2766 • Fax: (972) 247-7656

**Mason-Kansas City** • 1912 East 19th Street  
Kansas City, MO 64127  
Telephone: 1/800/925-0291 • Fax: (816) 241-7314

**Mason-Raleigh** • 1601 Lake Wheeler Road  
Raleigh, NC 27603  
Telephone: 1/800/476-2593 • Fax: (919) 836-1944

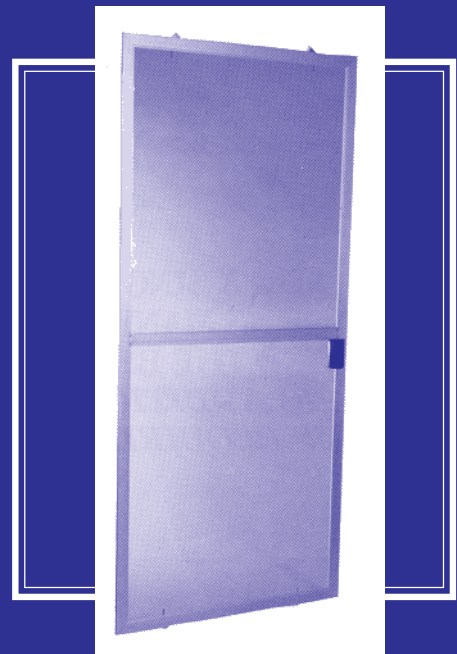

# SLIDING PATIO SCREEN DOORS - LINEALS & COMPONENTS

## MAIN FRAME

D100      Almond                      .040" extruded aluminum  
             Anodized  
             Dark Bronze  
             Mill Finish  
             Sun Sand  
             White

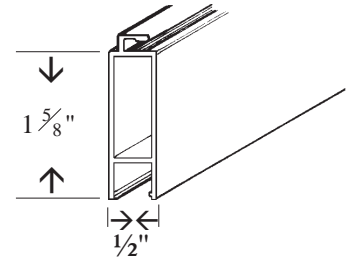

Standard Lengths: 10', 11'.  
                             Dark Bronze also available in 12' 3" lengths.

Standard Package: 12 each

*Use D600 corner inserts.*

## HAND DIE & JIG

T640

T640 Hand Die

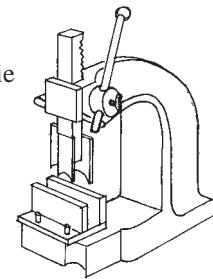

*Used to punch and lance screen door main frame for latch and rollers.  
 Includes T700 drill jig which locates holes for adjusting screw.*

## MULLION, with spline grooves

D101      Dark Bronze                      .040 extruded aluminum  
             White  
             Anodized

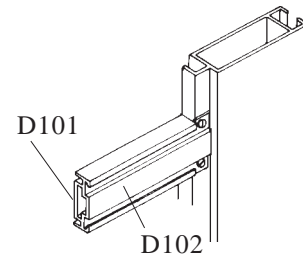

Standard Lengths: 12'  
 Standard Package: 12 each

## MULLION (FLAT BAR)

D102      Dark Bronze                      .040 aluminum  
             White  
             Anodized

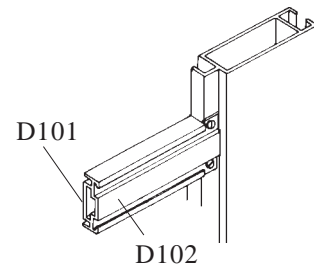

Standard Lengths: 12'  
 Standard Package: 12 each



## SLIDING PATIO SCREEN DOORS - LINEALS & COMPONENTS

### 1 1/2" VINYL BUGSTRIP

D300      Black

Standard Package: 250' roll

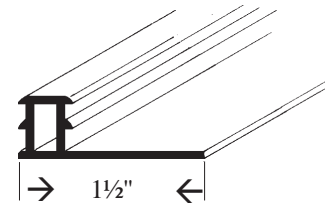

### SPLINE

C334.      Black                      .170 diameter hollow vinyl  
              Black Serrated

Standard Package: 1000' roll

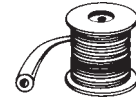

### ROLLER

D395      Mill Finish      Steel patio screen door tension roller

Standard Package: 25 per package

D400      Mill Finish      Nylon patio screen door tension roller

Standard Package: 25 per package

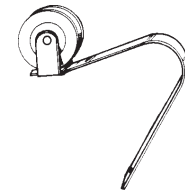

### TOP GUIDE

D401      White      5/8"

Standard Package: 5/8", 100 per package

D403      White      3/4"

Standard Package: 100 per package

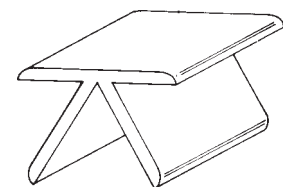

### CORNER INSERT

D600      Mill Finish

Standard Package: 24 each per package

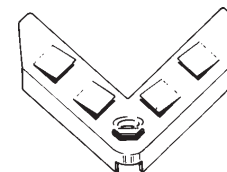

# SLIDING PATIO SCREEN DOORS - LINEALS & COMPONENTS

## LATCH ASSEMBLY

D500      Black

Standard Package: 6 ea. per package  
Includes 1 of each item  
shown except pop rivets.

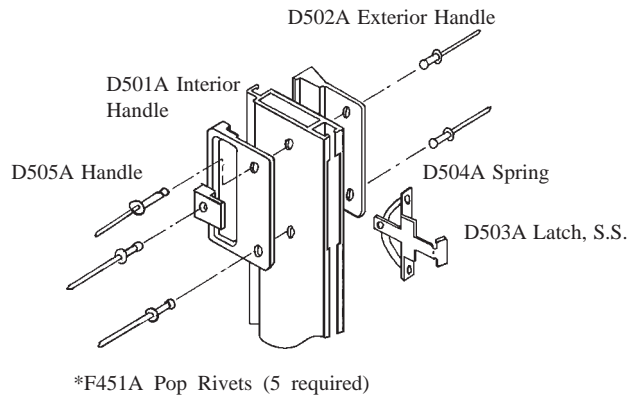

## STRIKE PLATE

D506      Molded Plastic

Standard Package: As required  
Use with sliding patio screen door latch.

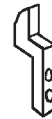

## TOP ROLLER MOUNTING STRIP

D700      Anodized      30", 36", 48"

Uses 2 each D703 rollers and 2 each F404 screws.

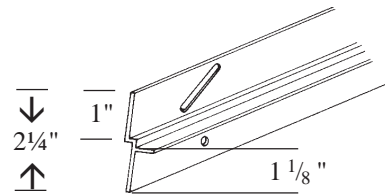

## ROLLER

D703      Mill Finish

Standard Package: 100 ea. per package

Use with D700. Use F404A screw.

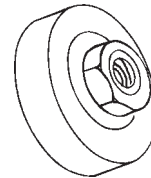

## ADJUSTMENT SCREW

D803      Mill Finish      #8 x 1 1/4" Phillips head

Standard Package: 100 ea.



## POP RIVET

F451      Mill Finish      1/8" diameter with .126  
Dark Bronze      to .187 grip range  
White

Standard Package: 100 each per package

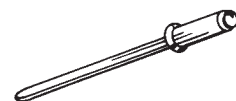

**MASON CORPORATION**  
123 Oxmoor Road, West  
Birmingham, AL 35209-6302

Telephone: 1/800/868-4100  
Fax: 205/945-4399

# SLIDING PATIO SCREEN DOORS - LINEALS & COMPONENTS

## PRE-PUNCHED FRAME SET\*

D830	Dark Bronze White Anodized	2'6" x 6'8" door
D836	Dark Bronze White Anodized	3'0" x 6'8" door
D848	Dark Bronze White Anodized	4'0" x 6'8" door

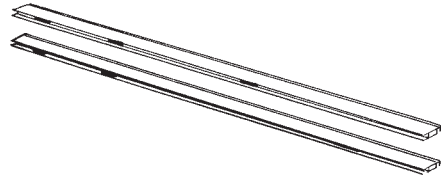

*Includes D831 Hardware Kit.*

*\*Frame sets are not pre-cut and mitred.*

## ASSEMBLY INSTRUCTIONS

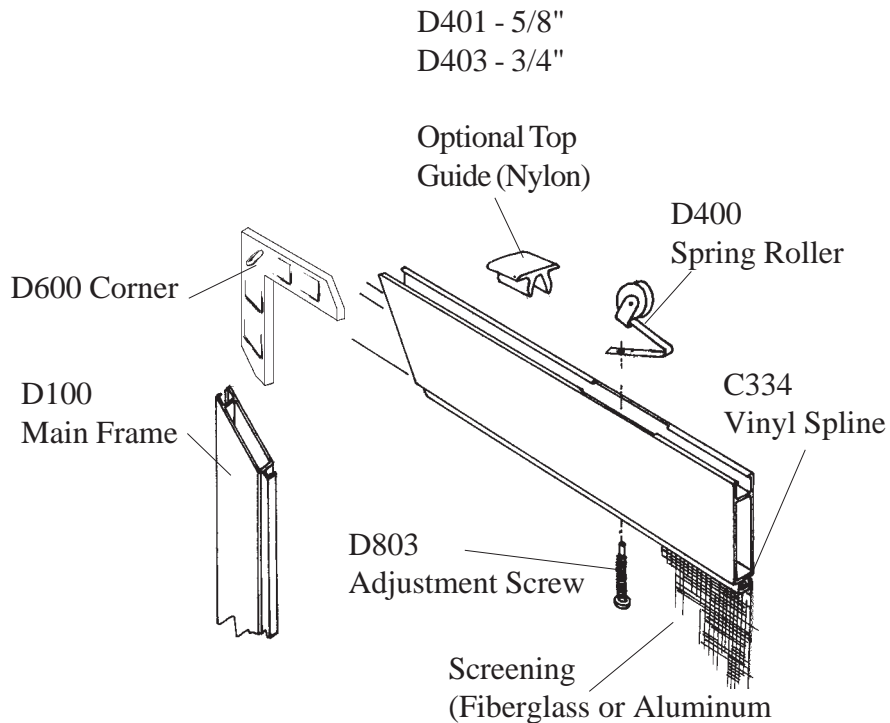

**MASON CORPORATION**  
 123 Oxmoor Road, West  
 Birmingham, AL 35209-6302

Telephone: 1/800/868-4100  
 Fax: 205/945-4399

# SLIDING PATIO SCREEN DOORS - LINEALS & COMPONENTS

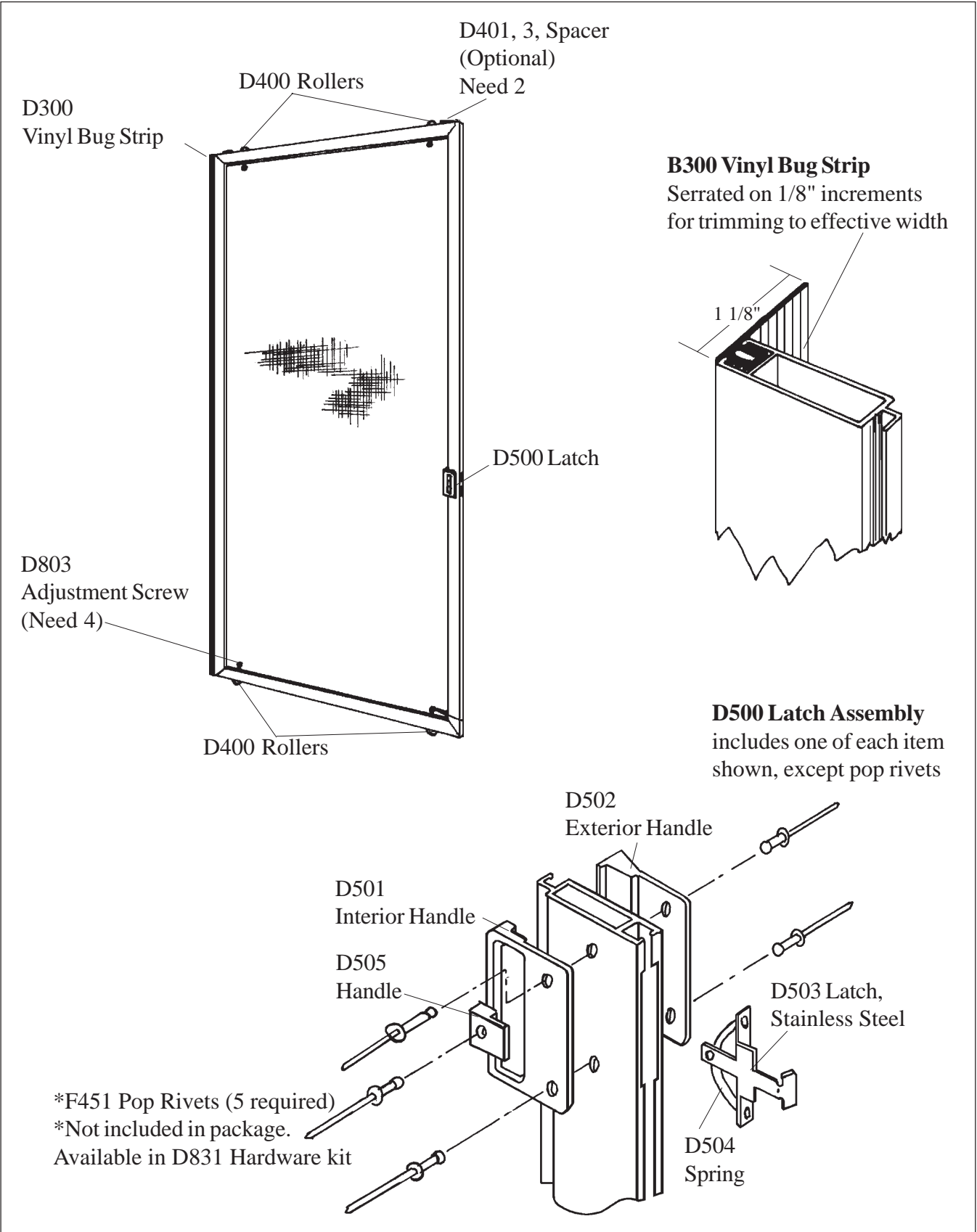

**MASON CORPORATION**  
 123 Oxmoor Road, West  
 Birmingham, AL 35209-6302

Telephone: 1/800/868-4100  
 Fax: 205/945-4399