

***E SERIES CATALOG***  
***Fixed Window***  
***and***  
***Storm Window***  
***Lineals and Components***

**CORPORATE OFFICE**

123 OXMOOR ROAD WEST • BIRMINGHAM, AL 35209  
P.O. Box 59226 • BIRMINGHAM, AL 35259-9226  
TELEPHONE: 1/800/868-4100  
FAX: (205) 945-4304

MASON-DALLAS • 2080 MCDANIEL, STE. 125  
CARROLLTON, TX 75006  
TELEPHONE: 1/800/756-2766 • FAX: (972) 247-7656

MASON-KANSAS CITY • 1912 EAST 19TH STREET  
KANSAS CITY, MO 64127  
TELEPHONE: 1/800/925-0291 • FAX: (816) 241-7314

MASON-RALEIGH • 1601 LAKE WHEELER ROAD  
RALEIGH, NC 27603  
TELEPHONE: 1/800/476-2593 • FAX: (919) 836-1944

MASON-KNOXVILLE • 4610 COSTER ROAD  
KNOXVILLE, TN 37912  
TELEPHONE: 1/800/961-6266 • FAX: (865) 687-3841

MASON-LITTLE ROCK • 700 NORTH PALM  
NORTH LITTLE ROCK, AR 72114  
TELEPHONE: 1/800/611-5162 • FAX: (501) 955-2147





**FIXED WINDOW AND STORM WINDOW LINEALS AND COMPONENTS**

**MAIN FRAME FOR PICTURE WINDOW**

E100 Dark Bronze .055" extruded aluminum  
 White  
 Anodized

Standard Package: 30 pcs. 16' length  
 Use F653B glazing bead for 1/8" glass and F654B for 3/16",  
 7/32" and 1/4" glass.  
 Use T760A drill jig.

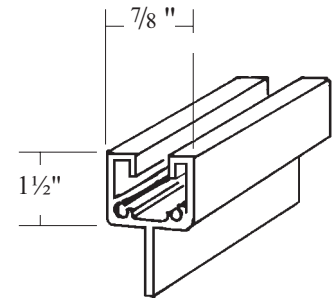

**MAIN FRAME HEAD AND SILL**

E107 Bronze .045" extruded aluminum  
 Mill  
 Ivory  
 White

Standard Package: (480') 30 pcs. 16' length  
 For aluminum prime and blind stop window installation.  
 Offset style.  
 Use E803 corner screws.

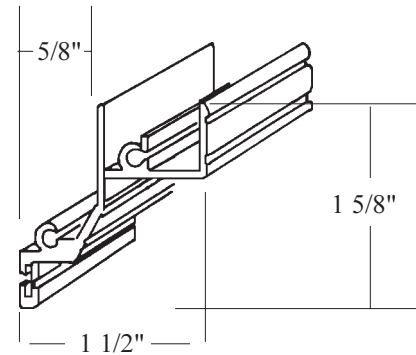

**MAIN FRAME JAMB**

E108 Bronze .045" extruded aluminum  
 Mill  
 Ivory  
 White

Standard Package: (480') 30 pcs. 16' length  
 For aluminum prime and blind stop window installation.  
 Offset style.

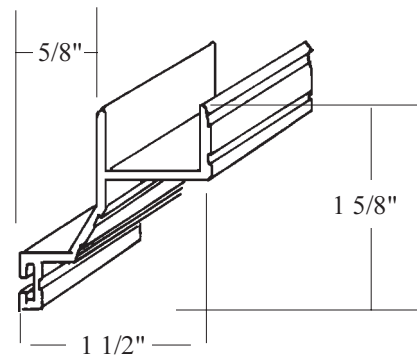

**MAIN FRAME HEAD AND SILL**

E113 Bronze .045" extruded aluminum  
 Mill  
 White

Standard Package: (480') 30 pcs. 16' length  
 For blind stop OR OVERLAP window installation.  
 Use E803 corner screws.

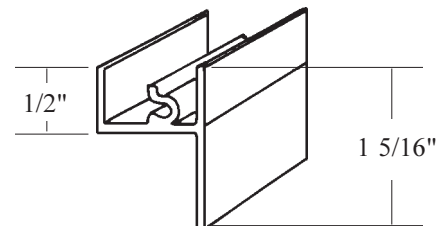

**FIXED WINDOW AND STORM WINDOW LINEALS AND COMPONENTS**

**MAIN FRAME JAMB**

E114 Bronze .045" extruded aluminum  
 Mill  
 White

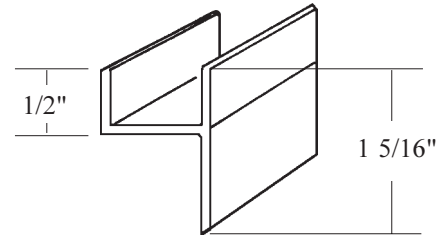

Standard Package: (480') 30 pcs. 16' length  
*For blind stop or overlap installation.*

**GLASS MOLD, E-Z GLAZE**

E210 Mill Finish .024" roll formed aluminum  
 Dark Bronze  
 White

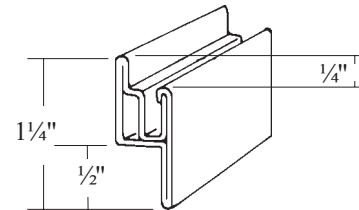

Standard Package: (525') 42 pcs. 12'6" length  
*For single or double strength glass. Use E606 glazing bead and E709 corner inserts. For single strength glass use E651 bedding tape.*

**GLASS MOLD WITH VINYL WEATHERSTRIP**

E224 Mill Finish .024" roll formed aluminum  
 Ivory  
 Bronze  
 White

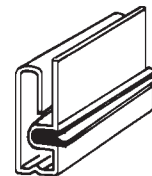

Standard Package: (1,008') 84 pcs. 12' length  
*For single or double strength glass.  
 Use E704 corner inserts and E702 corner clips.*

**GLASS MOLD WITH PILE WEATHERSTRIP**

E301 Bronze .020" roll formed aluminum  
 Mill  
 White

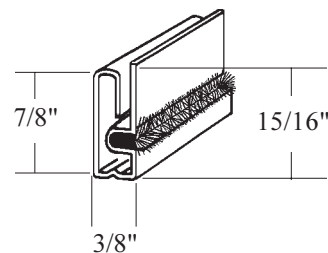

Standard Package: (1,050') 84 pcs. 12'6" length  
 (1,344') 84 pcs. 16' length

*For single or double strength glass.  
 Use E704 corner inserts and E702 corner clips.*



**FIXED WINDOW AND STORM WINDOW LINEALS AND COMPONENTS**

**GLAZING BEAD**

F653      Black      Vinyl, wrap around

Standard Package: 500' roll  
 For 1/8" glass.



**GLAZING BEAD**

F654      Black      Vinyl, wrap around

Standard Package: 500' roll  
 For 3/16", 7/32", and 1/4" glass.



**GLAZING BEAD**

E606      Black      Vinyl

Standard Package: 500' roll  
 Drop-in type. Use to glaze E210  
 E-Z Glaze glass mold.

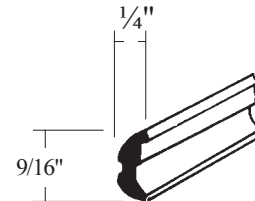

**WEATHERSTRIPPING**

E645      Black      Vinyl  
             Clay  
             White  
             Ivory

Standard Package: 1,000' roll  
 Bulb type. Used for Panorama and Clearview enclosures.

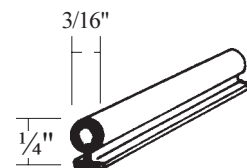

**TITE-PAK TAPE**

E651                      1/4" wide

Standard Package: 150' roll  
 Pressure sensitive back. Use as glass bedding  
 on E210 glass mold.

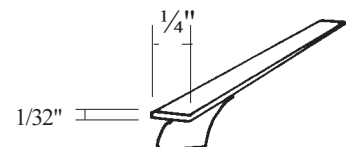

**FIXED WINDOW AND STORM WINDOW LINEALS AND COMPONENTS**

**THERMAL ISOLATOR BEAD**

E678 Black

Standard Package: 500' roll

*Use to weatherstrip and insulate between storm window and metal prime windows.*

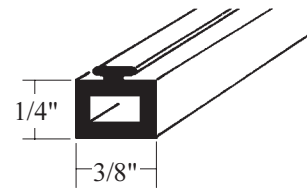

**CORNER LATCH, LONG NOSE**

E540 Black Zinc die cast

Standard Package: 100 sets (1 right and 1 left)

*Use with E224 and L162 glass molds.  
(Thumb screws not included.)*

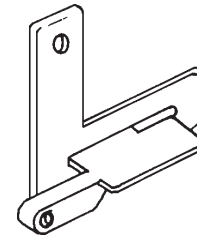

**ANGLE**

E680 Dark Bronze .050" extruded aluminum  
White

Standard Length: 12'

Standard Package: As required

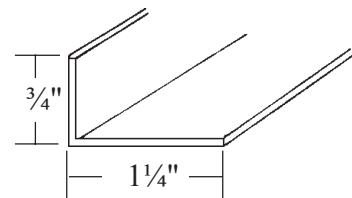

**ALL PURPOSE ANGLE**

E700 Mill Finish .125 extruded aluminum,

Standard Length: 12'

Standard Package: As required

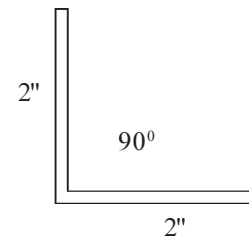

**EXTRUDED ALUMINUM MULLION**

E773 Bronze  
Mill  
Ivory  
White

Standard Package: (800') 50 pcs. 16' length

*Use at meeting rails of all self storing storm windows and doors.*

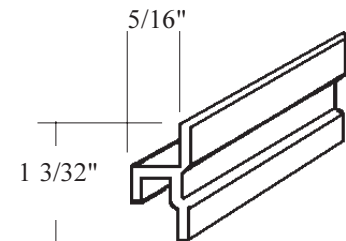

## FIXED WINDOW AND STORM WINDOW LINEALS AND COMPONENTS

### WIRE CORNER CLIP

E702 Mill Finish

Standard Package: 100 sets (8 clips per set)  
*To fasten corners of roll formed E224 and L162 glass molds.*

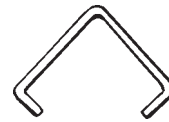

### CORNER INSERT

E704 Mill Finish .090" stamped aluminum

Standard Package: 100 sets (4 per set)  
*Use in roll formed E224, E301 and L162 glass molds.*

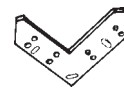

### CORNERINSERT

E709 Mill Finish 1/8" stamped aluminum

Standard Package: 100 sets (4 per set)  
*For E210 E-Z Glaze glass mold.*



### THUMB SCREW, DELRIN

E406 Black

Standard Package: 200 each  
*Use with E540 corner latch.*



### CORNERSCREW

E803 Mill Finish #8-18 x 1" , #410 st. steel  
 Bronze  
 Ivory  
 White

Standard Package: 100 each  
*Round head, square recess, 1/4" lead point,  
 brite hardened, passivated and waxed.*

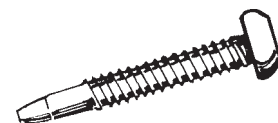

**MASON CORPORATION**  
 123 Oxmoor Road, West  
 Birmingham, AL 35209-6302

Telephone: 1/800/868-4100  
 Fax: 205/945-4304

## FIXED WINDOW AND STORM WINDOW LINEALS AND COMPONENTS

### SHEET METAL SCREW

E808      Mill Finish      #8-18 x 9/16", #410 st. steel  
             Bronze  
             Ivory  
             White



Standard Package: 500 each  
*Square socket pan head, type AB, brite hardened.*

### INSTALLATION SCREW

E809      Mill Finish      #8-18 x 3/4", #410 st. steel  
             Bronze              sheet metal screw.  
             Ivory  
             White

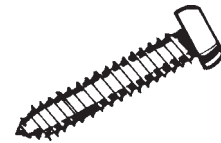

Standard Package: 100 each  
*Square socket pan head, type AB, brite hardened.*

### PIANO HINGE

E003                      .050" aluminum with 1½" flanges  
  
 Continuous piano type hinge. 72" holes on 6" centers

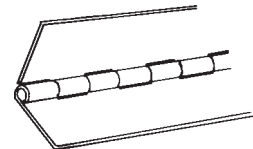

### ACRY-LAR SEAM SEALER

E006      Bronze  
             Mill  
             White

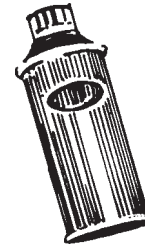

Standard Package: 16 oz. cans

