

H SERIES CATALOG

SCREEN ENCLOSURES LINEALS & COMPONENTS

Corporate Office

123 Oxmoor Road West • Birmingham, AL 35209
P.O. Box 59226 • Birmingham, AL 35259-9226
Telephone: 1/800/868-4100
Fax: (205) 945-4304

Mason-Dallas • 2080 McDaniel, Suite 125
Carrollton, TX 75006
Telephone: 1/800/756-2766 • Fax: (972) 247-7656

Mason-Kansas City • 1912 East 19th Street
Kansas City, MO 64127
Telephone: 1/800/925-0291 • Fax: (816) 241-7314

Mason-Raleigh • 1601 Lake Wheeler Road
Raleigh, NC 27603
Telephone: 1/800/476-2593 • Fax: (919) 836-1944



2" EXTRUDED SCREEN ENCLOSURES - LINEALS & COMPONENTS

CORNER POST

H120 Dark Bronze .048" Extruded aluminum
 White
 Clay

Standard Package: 8 each
 Stock Lengths: 16'

*Accepts kickplate.
 Use .220" diameter spline (C336B).*

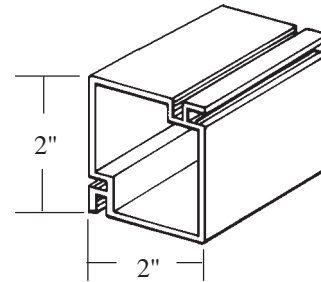

MAIN FRAME

H121 Dark Bronze .048" Extruded aluminum
 White
 Clay

Standard Package: 20 each
 Stock Lengths: 16', 20'

*Accepts kickplate. Use .220" diameter spline (C336B)
 and H410 screws.*

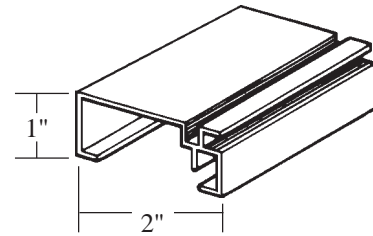

MAIN FRAME

H122 Dark Bronze .048" Extruded Aluminum
 White
 Clay

Standard Package: 8 each
 Stock Lengths: 16' and 20'

*Accepts kickplate.
 Use .220" diameter spline (C336B).*

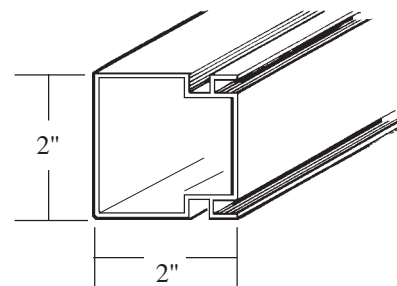

2" EXTRUDED SCREEN ENCLOSURES - LINEALS & COMPONENTS

CHANNEL

H123 Dark Bronze .050" Extruded Aluminum
 White
 Clay

Standard Package: 20 each
 Stock Lengths: 16' and 20'

*Receives H120, H121, or H122 main frame.
 Use H410 screws.*

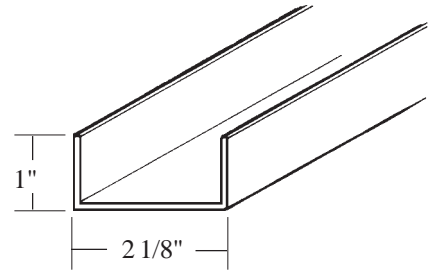

CHANNEL

H124 Dark Bronze .050" Extruded Aluminum
 White
 Clay

Standard Package: 12 each
 Stock Lengths: 16' and 20'

*Receives H120, H121, or H122 main frame.
 Use H410 screws.*

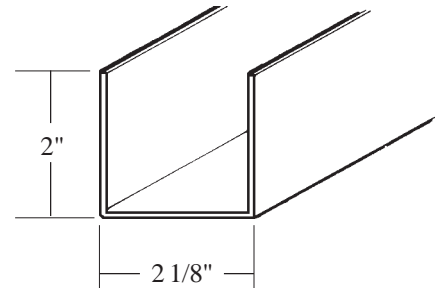

ANGLE

H125 Mill Finish .062" Extruded Aluminum

Stock Lengths: 12'

All purpose angle.

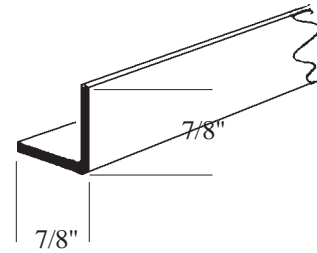

MUNTIN CLIP

H126 Mill Finish .062" Extruded Aluminum
 White

Standard Package: 50 each.

*Use to attach H121 horizontal muntin to H122 and H120.
 Use T740 drill jig.*

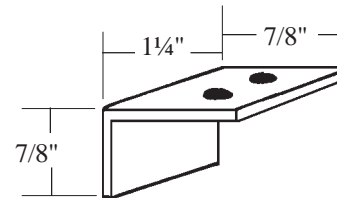

MASON CORPORATION
 123 Oxmoor Road, West
 Birmingham, AL 35209-6302

Telephone: 1/800/868-4100
 Fax: 205/945-4304

2" EXTRUDED SCREEN ENCLOSURES - LINEALS & COMPONENTS

FOAM TAPE

H310 Gray ¾" X ¾" Polyurethane with pressure sensitive backing

Standard Package: 15' rolls.

Use to seal between uneven walls and porch enclosure.

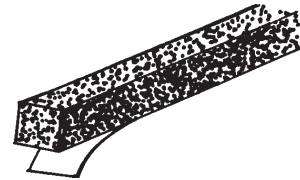

TEK® SCREW

H410 Bronze #8 - 18 x ½" hex, plated
White
Ivory
Clay

Standard Package: 100 each.

Use T314A chuck.



CLOSER BRACKET

H460 Black Vinyl

Standard Package: As required.

Use on 2" X 2" porch enclosure door jamb to receive closer rod and provide proper spacing for correct closer operation.

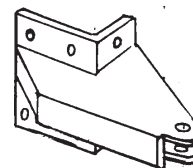

ROUND VINYL SPLINE

C336B Black .220" vinyl, non-serrated
C336S Black .225" vinyl, serrated (1,000' roll only)

Standard Package: 500' and 1,000' rolls.

Use with H120, H121, and H122.

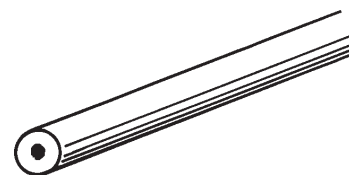

MASON CORPORATION
123 Oxmoor Road, West
Birmingham, AL 35209-6302

Telephone: 1/800/868-4100
Fax: 205/945-4304

2" EXTRUDED SCREEN ENCLOSURES - LINEALS & COMPONENTS

KICK PLATE COIL

F250 Dark Bronze .024", 18" wide, embossed aluminum
 Ivory
 White
 Clay
 Mill Finish



Standard Package: 50' roll.

F252 Dark Bronze .024", 24" wide embossed aluminum
 Ivory
 White
 Clay

Standard Package: 50' roll

SCREEN CLOTH

Fiberglass Gray
 Charcoal

Standard Package: 100' roll.

*Stock Widths: 24", 26", 28", 30", 32",
 34", 36", 42", 48", 60", 72"

*Other widths available upon request.

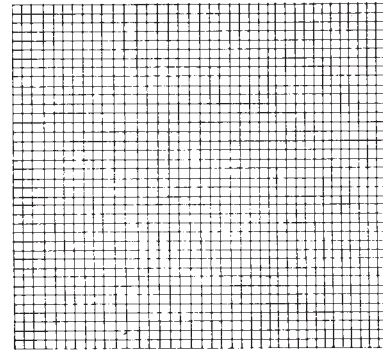

SCREEN DOOR

F827 Dark Bronze K.D., 3'0" x 6'8" or 2'8" x 6'8"
 Ivory
 White
 Clay

F828 Dark Bronze Assembled, 3'0" x 6'8" or 2'8" x 6'8"
 Ivory
 White
 Clay

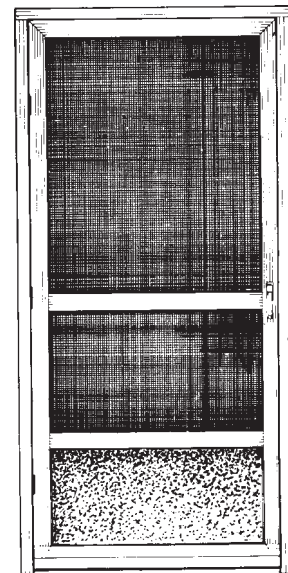

MASON CORPORATION
 123 Oxmoor Road, West
 Birmingham, AL 35209-6302

Telephone: 1/800/868-4100
 Fax: 205/945-4304

2" EXTRUDED SCREEN ENCLOSURES - LINEALS & COMPONENTS

JOB SITE INSTALLATION AND FABRICATION OF THE MASON SCREEN ENCLOSURE

H123 1" X 2" CHANNEL OR
H124 2" X 2" CHANNEL,
6063-T5 EXTRUDED ALUMINUM

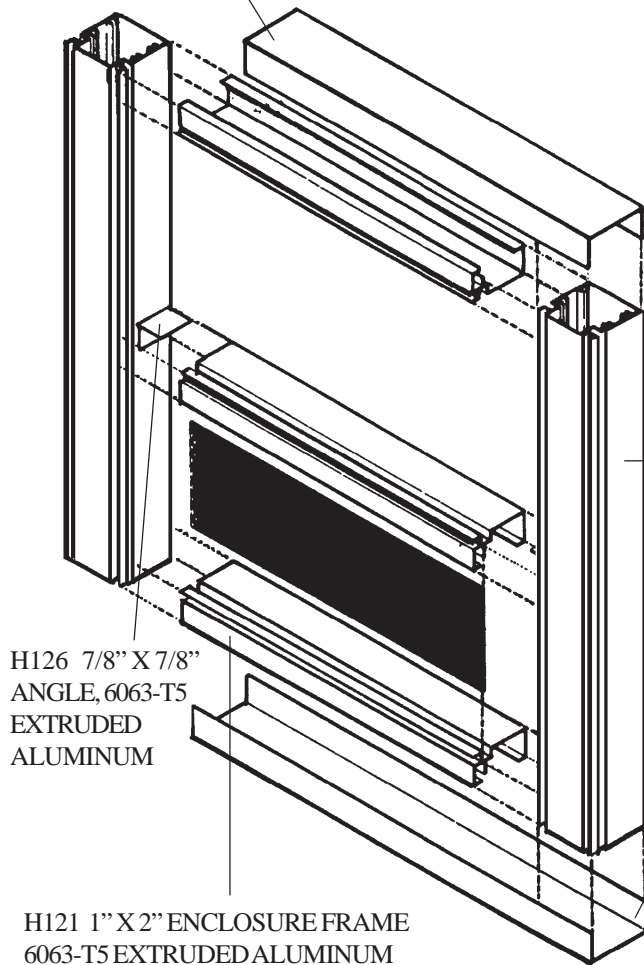

H126 7/8" X 7/8"
ANGLE, 6063-T5
EXTRUDED
ALUMINUM

H121 1" X 2" ENCLOSURE FRAME
6063-T5 EXTRUDED ALUMINUM

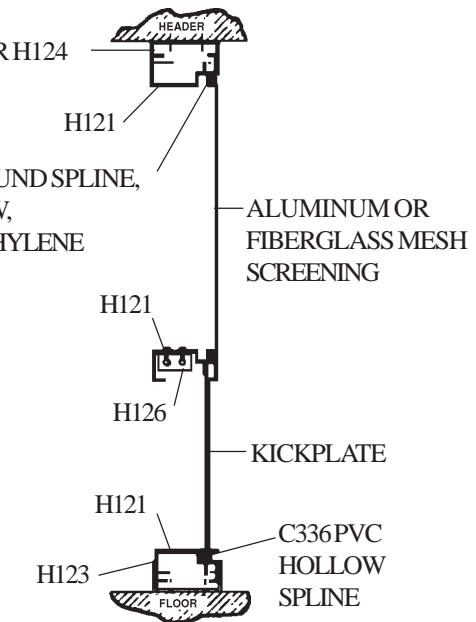

H123 OR H124

H121

C336 ROUND SPLINE,
HOLLOW,
POLYETHYLENE

ALUMINUM OR
FIBERGLASS MESH
SCREENING

H121

H126

KICKPLATE

H121

C336 PVC
HOLLOW
SPLINE

H123

FLOOR

H122 ENCLOSURE FRAME,
6063-T5 EXTRUDED ALUMINUM

H123 1" X 2" CHANNEL,
6063-T5 EXTRUDED ALUMINUM



2" ROLL FORMED SCREEN ENCLOSURES - LINEALS & COMPONENTS

1" X 2" MAIN FRAME

H500 Dark Bronze .040" roll formed aluminum,
 Ivory ½" groove depth
 White
 Clay

Standard Package: 14 pcs. per box
 Stock Lengths: 16', 20', 24'

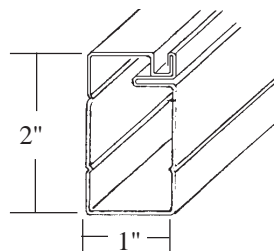

Use C340 square spline, C341 star spline, or C333 serrated spline.

REINFORCEMENT CHANNEL

H502 Mill Finish .040" aluminum

Stock Lengths: 12'

*Fits inside 2" x 2" frame for reinforcement
 when attaching doors or door hardware.*

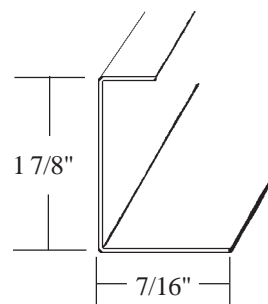

2" X 2" MAIN FRAME

H503 Dark Bronze .040" roll formed aluminum,
 Ivory ½" kick plate groove depth
 White
 Clay

Standard Package: 8 pcs. per box.
 Stock Lengths: 16', 20', 24'

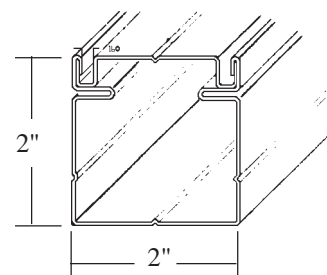

Use C340 square spline, C341 star spline, or C333 serrated spline.

1" X 2" EXPANDER CHANNEL, Top, Bottom, and Wall

H507 Dark Bronze .040" roll formed aluminum
 Ivory
 White
 Clay

Standard Package: 20 pcs. per box.
 Stock Lengths: 16', 20'

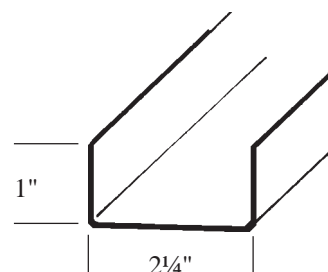

MASON CORPORATION
 123 Oxmoor Road, West
 Birmingham, AL 35209-6302

Telephone: 1/800/868-4100
 Fax: 205/945-4304

2" ROLL FORMED SCREEN ENCLOSURES - LINEALS & COMPONENTS

2" X 2" EXTRUDED CORNER POST

H127 Dark Bronze .050" extruded aluminum
Ivory
White
Clay

Standard Package: 8 pcs. per box
Standard Lengths: 16'

Use C340 (.135) square spline, C341 (.145) star spline, or C333 (.155) serrated spline.

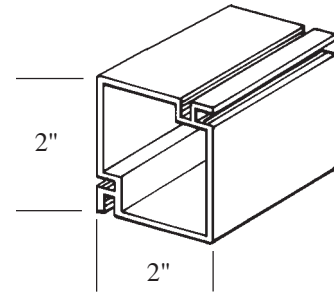

KICK PLATE COIL

F250 Mill Finish .024", 18" wide, embossed aluminum
Dark Bronze
Ivory
White
Clay
F252 Dark Bronze .024", 24" wide embossed aluminum
Ivory
White
Clay



Standard Package: 50' roll

CORNER INSERT, 1" X 2"

H508 Mill Finish .050" stamped aluminum corner

Standard Package: 100 each

Use with 1" x 2" main frame when making 1" x 2" screen panels.

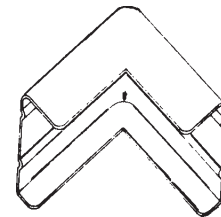

CLOSER BRACKET

H460 Black Vinyl

Standard Package: As required.

Use on 2" X 2" screen enclosure door jamb to receive closer rod and provide proper spacing for correct closer operation.

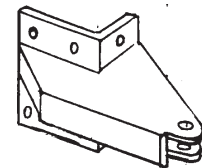

MASON CORPORATION
123 Oxmoor Road, West
Birmingham, AL 35209-6302

Telephone: 1/800/868-4100
Fax: 205/945-4304

2" ROLL FORMED SCREEN ENCLOSURES - LINEALS & COMPONENTS

FOAM TAPE

H310 Gray 3/4" X 3/4" Polyurethane with pressure sensitive backing

Standard Package: 15' rolls.

Use to seal between uneven walls and porch enclosure.

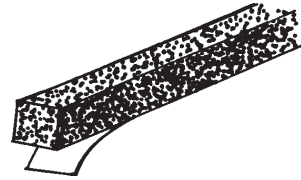

PIN GRIP DRIVE ANCHORS

A421 Mill Finish 1/4" X 1" aluminum body with stainless steel drive pin

Standard Package: 100 each

Use to attach 1" x 2" U-Channel to concrete.

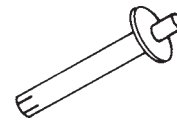

INSIDE END CLIP

H510 Mill Finish stamped aluminum clip

Standard Package: 100 each

Use to join two pieces of 2" x 2" (H503) main frame.

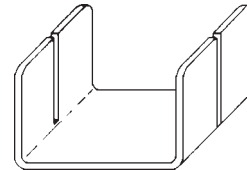

END CLIP

H506 Dark Bronze .040" stamped aluminum
Ivory
White
Clay

Standard Package: 100 each

Use to connect 1" x 2" main frame to framework.

H511 Dark Bronze .040" stamped aluminum
Ivory
White
Clay

Standard Package: 100 each

Use to connect 2" x 2" main frame to framework.

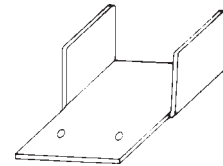

MASON CORPORATION
123 Oxmoor Road, West
Birmingham, AL 35209-6302

Telephone: 1/800/868-4100
Fax: 205/945-4304

2" ROLL FORMED SCREEN ENCLOSURES - LINEALS & COMPONENTS

SPLINE

CATALOG NUMBER	DESCRIPTION	DIAMETER	STANDARD PACKAGE
C333	Round spline	.150"	2,000' roll
C333	Serrated spline	.155"	500' & 2000' rolls
C334	Round spline	.170"	1,000' roll
C334	Serrated spline	.175"	500' & 2000' rolls
C336	Round spline	.220"	500' & 1,000' rolls
C336	Serrated spline	.225"	1000' roll
C340	Square serrated	.135"	2,000' roll
C341	Star spline	.145"	2,000' roll

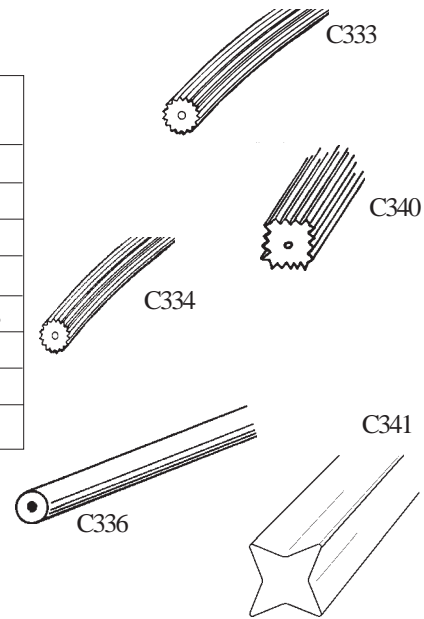

Use to roll screen into spline grooves.

SCREEN CLOTH

Fiberglass Gray
 Charcoal

Standard Package: 100' roll.

*Stock widths: 24", 26", 28", 30", 32", 36",
42", 48", 60", 72"

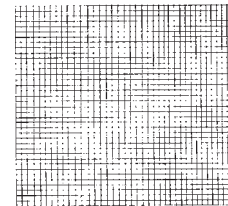

*Other widths available upon request.

SCREEN DOOR

F827 Dark Bronze K.D., 3'0" x 6'8" or 2'8" x 6'8"
 Ivory
 White
 Clay

F828 Dark Bronze Assembled, not pre-hung,
 Ivory 3'0" x 6'8" or 2'8" x 6'8"
 White
 Clay

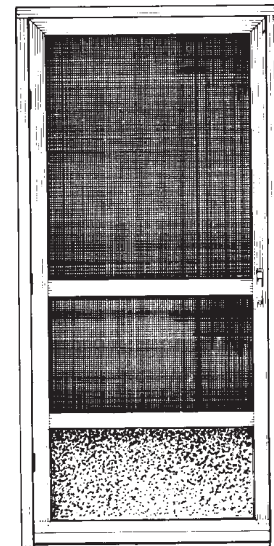

2" ROLL FORMED SCREEN ENCLOSURES - LINEALS & COMPONENTS

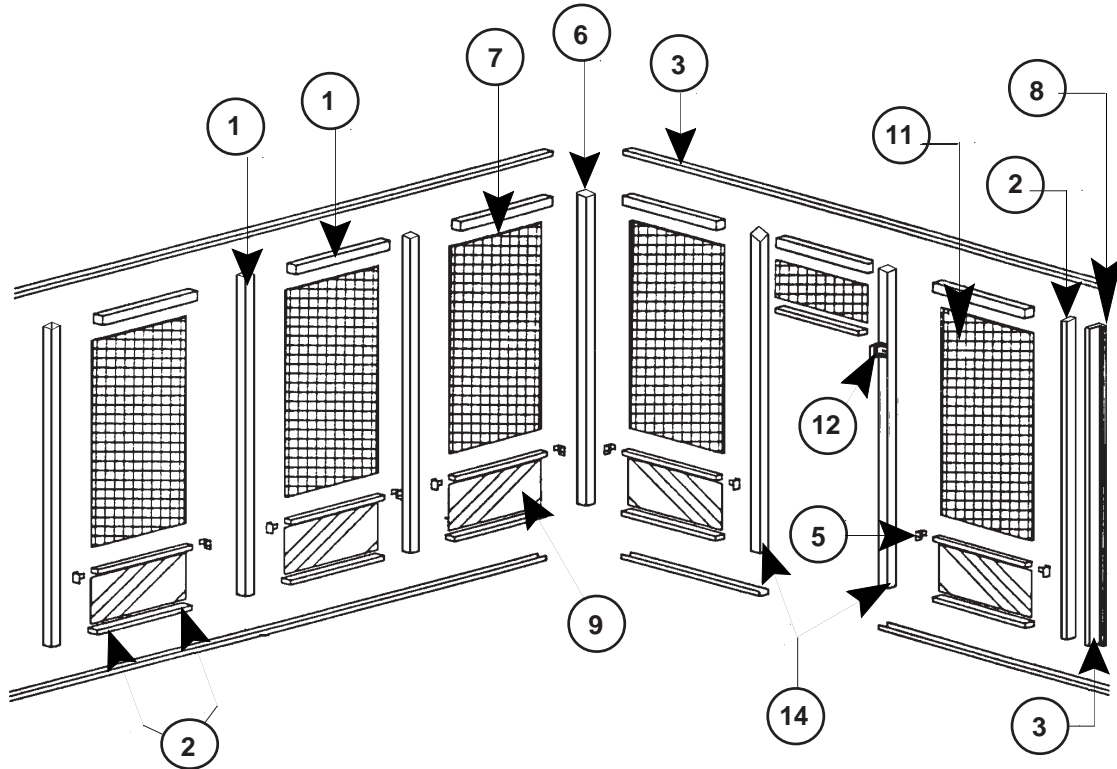

1		Cat. # H503 Main Frame 2" X 2"	7		Cat. # C333 Spline	12		Cat. # H460 Door Bracket
2		Cat. # H500 Main Frame 1" X 2"	8		Cat. # H310 Wall Sealing Tape	13		Cat. # F828 Assembled Screen Door
3		Cat. # H507 Expander Channel	9		Cat. # F250 F252 Kickplate	14		Cat. # H502 Reinforcement Channel
4		Cat. # H511 "F" Clip for 2" X 2" Frame	10		Cat. # A421 Drive Pin Rivet			
5		Cat. # H506 "F" Clip for 1" X 2" Frame	11		G Series Screen Cloth			
6		Cat. # H127 2" X 2" Extruded Aluminum Corner Post						



MASON CORPORATION
123 Oxmoor Road, West
Birmingham, AL 35209-6302

Telephone: 1/800/868-4100
Fax: 205/945-4304

1" ROLL FORMED SCREEN ENCLOSURES - LINEALS & COMPONENTS

"F" EXPANDER, 1" X 1"

H101 Dark Bronze .050" extruded aluminum
 White

Standard Package: 25 each
 Stock Lengths: 16'
Use as floor channel and wall channel.

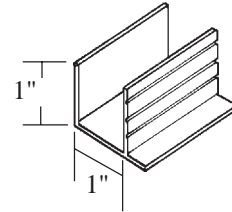

"H" MULLION, 1" X 1"

H102 Dark Bronze .050" extruded aluminum
 White
 Clay

Standard Package: 25 each
 Stock Lengths: 16'
Use as mullion between 1" wall panels.

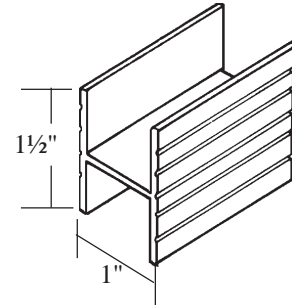

CORNER MULLION

H103 Dark Bronze .050" extruded aluminum
 White

Standard Package: 12 each
 Stock Lengths: 16'
Use as corner post for 1" enclosure.

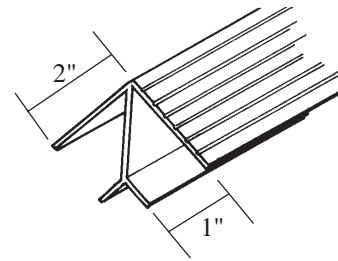

MAIN FRAME, 1" X 1"

H104 Mill Finish .030 roll formed aluminum
 Dark Bronze
 White
 Clay

Standard Package: (480') 30 pieces
 Stock Lengths: 16'
Use C334B spline and H401 corner inserts.

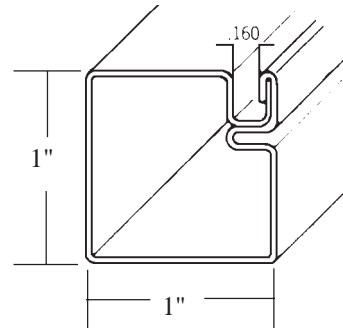

"F" EXPANDER, 2" X 1"

H105 Dark Bronze .050 extruded aluminum
 White

Standard Package: 20 each
 Stock Lengths: 16'
Use as top channel and can be used as wall channel.

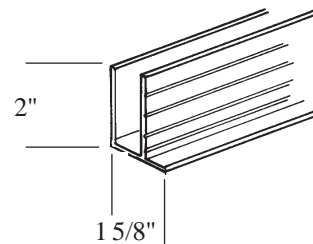

1" ROLL FORMED SCREEN ENCLOSURES - LINEALS & COMPONENTS

EXPANDER, 1" X 1"

H201 Dark Bronze .030 roll formed aluminum
 White
 Clay

Standard Package: (400') 25 pieces
 Stock Lengths: 16'

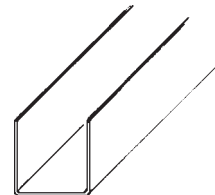

CORNER INSERT

H401 Mill Finish .050 stamped aluminum

Standard Package: 100 each

Use with H104 screen frame.

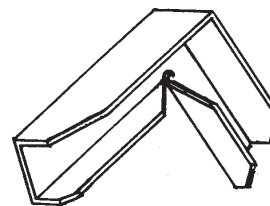

CENTER BAR/MULLION CLIP

H451 Mill Finish .062" Stamped Aluminum

Standard Package: 100 each.

Use with H104 screen frame, as mullion clip.

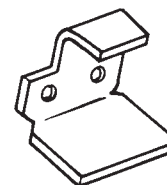

MULLION CLIP

H455 Mill Finish .062" stamped aluminum

Standard Package: 50 sets (50 rh and 50 lh)

Use with H104 screen frame, as mullion clip.

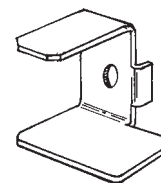

FOAM TAPE

H310 Gray 3/4" X 3/4" Polyurethane with pressure sensitive backing

Standard Package: 15' rolls.

Use to seal between uneven walls and porch enclosure.



MASON CORPORATION
 123 Oxmoor Road, West
 Birmingham, AL 35209-6302

Telephone: 1/800/868-4100
 Fax: 205/945-4304

1" ROLL FORMED SCREEN ENCLOSURES - LINEALS & COMPONENTS

PIN GRIP DRIVE ANCHORS

A421 Mill Finish ¼" X 1" aluminum body with stainless steel drive pin

Standard Package: 100 each

Use to attach 1" x 2" U-Channel to concrete.

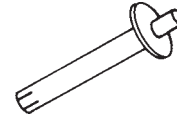

VINYL SPLINE, hollow

C334B Black .170" diameter, non-serrated

C334S Black .175" diameter, serrated

Standard Package: Non-serrated available in 1,000' roll.
Serrated available in 500' and 1000' rolls.

Use to apply screen mesh to H104 screen panel.

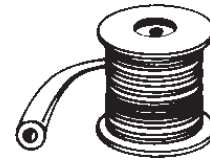

KICK PLATE COIL

F250 Mill Finish .024", 18" wide, embossed aluminum
Dark Bronze
Ivory
White
Clay

Standard Package: 50' roll.

F252 Dark Bronze .024", 24" wide embossed aluminum
Ivory
White
Clay

Standard Package: 50' roll



SCREEN CLOTH

Fiberglass Gray
Charcoal

Standard Package: 100' roll.

*Stock Widths: 24", 26", 28", 30", 32", 36",
42", 48", 60", 78"

*Other widths available upon request.

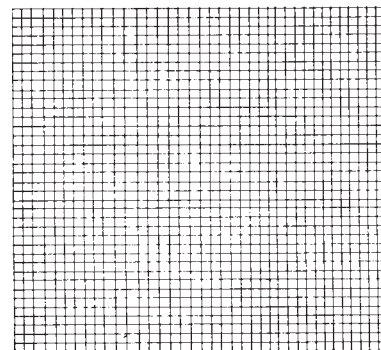

MASON CORPORATION
123 Oxmoor Road, West
Birmingham, AL 35209-6302

Telephone: 1/800/868-4100
Fax: 205/945-4304